

DEMAND SIDE LOAD MANAGEMENT IN THE DISTRIBUTION SYSTEM WITH PHOTOVOLTAIC GENERATION

Zvonimir Klaić, Krešimir Fekete, Damir Šljivac

Original scientific paper

Recently, there has been made a great effort to include electricity generation from the renewable energy sources into the power system. Random renewable generation creates the imbalance between electricity production and consumption, which requires power plants with fast response or energy storage systems. Generally accepted solution for load balancing is the concept of smart grids and one of the elements of smart grid efficiency is the ability of real-time demand-supply balancing. In this paper, the model of the part of power distribution network of the city of Osijek has been created based on results of the power measurements of total electricity consumption in a family house in Osijek, air conditioning system consumption and PV power plant production. Also, algorithm for real-time load management is proposed. It assumes coordinated control of air conditioning system units depending on the production of PV power plants and electricity consumption of distribution network, in order to reduce peak demand in the distribution network.

Keywords: demand side load management; distribution system; photovoltaic generation; real-time demand-supply balancing; smart grid

Upravljanje potražnjom u distribucijskom sustavu s fotonaponskim elektranama

Izvorni znanstveni članak

Posljednjih godina učinjen je znatan napor na uključivanju obnovljivih izvora električne energije u elektroenergetski sustav. Nepredvidiva proizvodnja obnovljivih izvora električne energije stvara neravnotežu između proizvodnje i potrošnje, što onda zahtijeva elektrane s brzim odzivom, ili sustave skladištenja električne energije. Opće prihvaćeno rješenje za uravnoteženje potrošnje je koncept naprednih mreža, a jedan od elemenata učinkovitosti naprednih mreža je sposobnost za uravnoteženje potražnje i opskrbe u stvarnom vremenu. U ovom radu razvijen je model dijela distribucijske mreže grada Osijeka i to na temelju rezultata mjerenja ukupne potrošnje obiteljske kuće u Osijeku, potrošnje klimatizacijskog uređaja te proizvodnje fotonaponske elektrane. Također, predložen je algoritam za upravljanje potražnjom u stvarnom vremenu. Algoritam sadrži usklađeno upravljanje klimatizacijskim uređajima ovisno o proizvodnji fotonaponskih elektrana te o potrošnji u distribucijskoj mreži, a u cilju snižavanja vršne potražnje u distribucijskoj mreži.

Ključne riječi: distribucijski sustav; napredne mreže; proizvodnja fotonaponske elektrane; upravljanje potražnjom; uravnoteženje potražnje i opskrbe u stvarnom vremenu

1 Introduction

In the last years, the electricity consumption is generally continuously increasing which leads to insufficient capacity problems in the power grid. Due to impossibility of solving all these problems on the supply side by adding new generation capacities, there is a great effort on inclusion energy production from the renewable energy sources all over the power system (especially in the distribution grid). Thus, modern distribution system becomes considerably decentralized.

The most common renewable energy sources connected in power networks are large wind turbines and PV (photovoltaic) parks as well as wide range of distributed sources like photovoltaic power plants on roofs and micro CHP (combined heat and power) on a domestic level [1, 2, 3]. Although distributed generation located in the distribution grid (near point of consumption) has many advantages for the grid itself (negligible distribution losses, increased reliability of generation, less need for transmission and distribution network capacity, etc.), this kind of generation facilities strongly rely on weather.

This leads to one of the main problems in distribution grids with renewable sources – load balancing [4]. Random renewable generation creates the imbalance between electricity production and consumption, which requires power plants with fast response or energy storage systems. Those fast adaptable power plants are usually less efficient peak plants.

Generally accepted solution for load balancing is the concept of smart grids. Most authors agree that smart grid

is a modernized electrical grid that integrates information and data communication technology to monitor and control generation, distribution, storage and consumption of energy to achieve improved efficiency, economics, security and reliability [5 ÷ 8]. Also, smart grid is a concept with many elements, where monitoring and control of every element in the chain of production, transmission, distribution and final consumption enables much more efficient delivery and use of electricity [9], and one of the elements of smart grid efficiency is the ability of real-time demand-supply balancing.

Demand side load management can increase the generation efficiency in two ways: by peak shaving and by shifting load to more beneficial periods [1]. Some of the home appliances (air conditioners, washing machines and dryers, freezers, heaters and refrigerators) can be temporarily switched off or postponed, without any strong impact on residents. Field tests in the USA have shown that optimizations with these appliances already can lead to significant peak reductions [1].

According to [10], demand side management (DSM) considers air-conditioning load as one of the most suitable loads to implement direct customer load control in order to exercise peak demand control as well as energy consumption control in supply systems. Therefore, some important researches have been carried out in this field. Evaluation of potential effectiveness of direct air conditioning load program was investigated in [11], dynamic model for direct load control (DLC) that takes into account weather condition was developed in [12] and various approaches to load forecasting of air conditioning were explored in [13]. Also, some authors investigated

schemes of periodic stopping of air conditioning taking into account human comfort index [14], and others used different programming methods to generate scheduling model [15 ÷ 18].

Besides these studies, there is an interesting example of the implementation of the power management in practice - City of Columbia, Missouri, USA, [19]. This program controls air conditioners and heat pumps in terms of circular turnoff. This turns the compressor motor off for 7,5 minutes each half-hour. So, the air-conditioner compressors for each home are turned off for a few minutes, and during the periods of peak electric usage instead of the four homes demanding electricity for their airconditioners at the same time, only three would demand.

In this paper, the results of the power measurements of total electricity consumption, air conditioning system consumption in a family house in Osijek and PV power plant production are presented and analysed. Based on the measurements carried out, the simulation model of the part of power distribution network of the city of Osijek has been created. Computer model is used to simulate several scenarios of the possible PV plant expansion.

Also, algorithm for real-time load management is proposed. It assumes coordinated control of air conditioning system units depending on the production of PV power plant and electricity consumption of distribution network, in order to reduce peak demand in

the distribution network. Installation of energy storage unit in distribution network is also suggested, which provides additional flexibility in the real-time load-production balancing. So the measurement results and proposed algorithm are used to simulate and analyse demand side load management in the distribution system considering photovoltaic plant expansion scenarios.

2 Description of the study area and research model

2.1 Description of the site

The first steps in this research were measurements in order to investigate possibilities of real-time consumption balancing in the distribution network in Osijek, Croatia. The measurements of 10 kWp photovoltaic power plant production, measurements of the air conditioning system consumption and measurements of total electricity consumption of family house were performed, Fig. 1. In most days, total electricity consumption of the family house in Osijek is below 1,5 kW. However, some consumption peaks which can reach 2,5 kW were also recorded.

Fig. 2 represents diagram with total consumption of the family house for a typical day near the end of summer – 8.9.2014. There are separate curves that show the consumption of air conditioner and residual consumption (total consumption of household without air conditioner consumption).

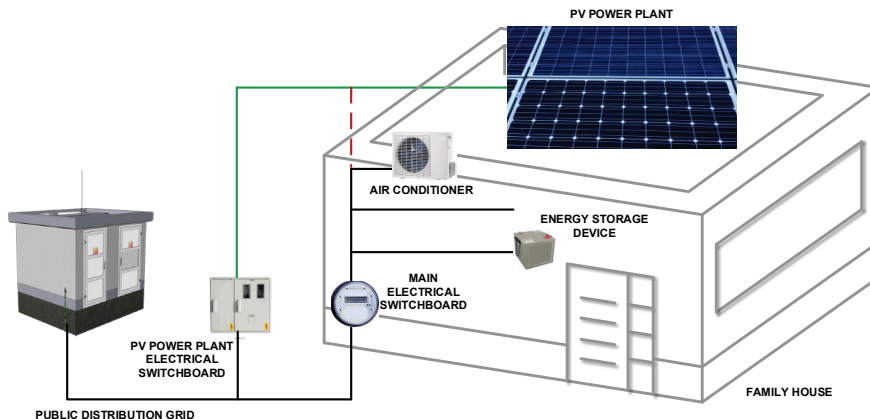

Figure 1 The family house in Osijek

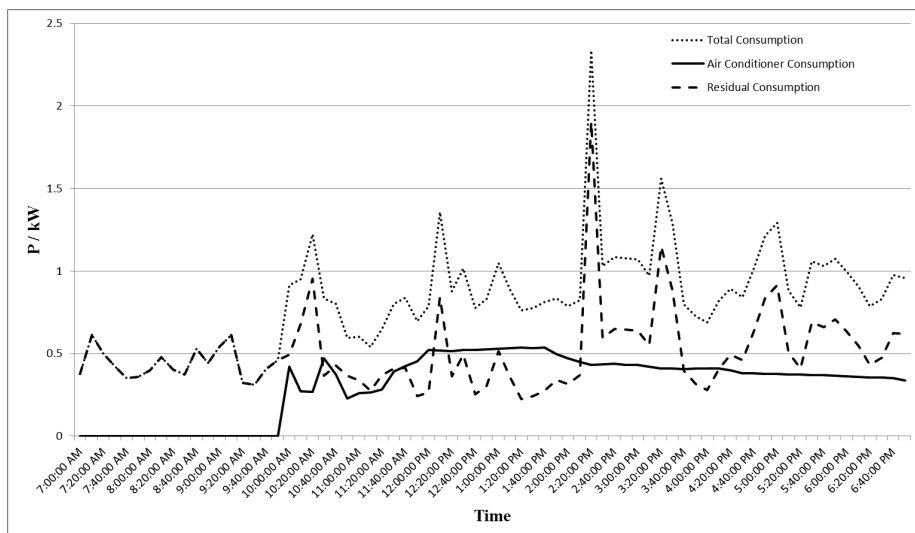

Figure 2 Total consumption of the family house for a typical day

The air conditioner, that is going to be used for modelling of load management, is Panasonic CS-RE9QKE with rated power of 700 W. The air conditioner is installed in the living room which is the largest room in the house and most widely in use.

PV power plant is composed of 40 PV modules of 250 W connected to two strings and strings are connected to an inverter. The inverter is connected via the electrical switchboard to the three phase LV distribution grid (230/400 V). The photovoltaic power plant production for already mentioned day is represented in Fig. 3.

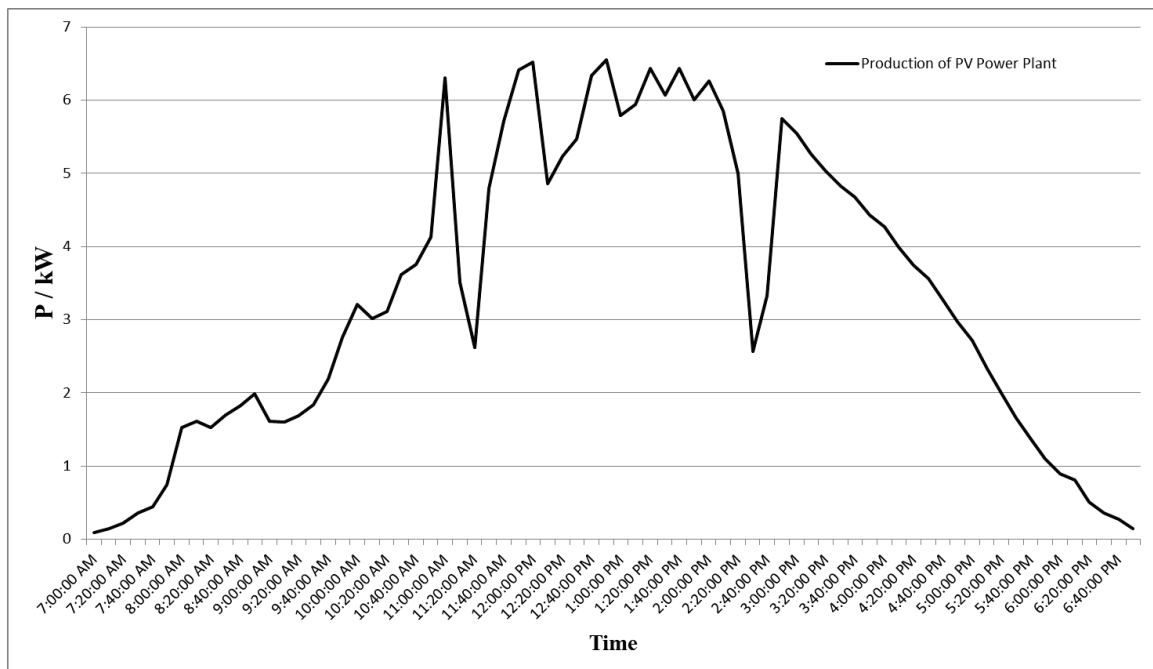

Figure 3 The photovoltaic power plant production for a typical day

2.2 Research model for demand side management

PowerWorld [20] software package is used to create a computer model of the PV power plant and local distribution network. The PV power plant is connected to the distribution grid as a part of the radial feeder connected to the transformer station 10/0,4 kV. In the simulation model, three radial feeders (with 20 family houses connected to each radial feeder) are connected to the 0,4 kV side of the transformer station as shown in Fig. 4. Only one radial feeder is modelled in detail with every family house included (two loads for every house represent the air conditioner consumption and the residual consumption). The other feeders are aggregated and presented as two loads (one for air conditioner consumption and the other for residual consumption) connected to the 0,4 kV side of the transformer.

Transformers data are: 10/0,4 kV, rated power $S_n = 630$ kVA, short-circuit voltage $u_{k\%} = 6$ %. The LV radial feeder is an overhead line ACSR 35 mm² with the following characteristics: $R = 0,835$ Ohm/km and $X = 0,3$ Ohm/km. The distance between two family houses is 20 m. External 10 kV distribution grid that is connected to the transformer is modelled with its maximum and minimum short-circuit powers: $S''_{k \max} = 50$ MVA and $S''_{k \min} = 5,2$ MVA.

Measurements were performed at two locations: total electricity consumption of family house and consumption of air conditioner were measured at house main electrical switchboard, and PV plant electricity production was measured at the PV plant AC electrical switchboard.

Measurements lasted for two weeks (started from 1 September 2014 and ended 15 September 2014). Power network analysers, accuracy class A (IEC 61000-4-30), supported by powerful mathematical software were used for measurements. As results, all analysers provide averaged 10-minute quantities (voltage, power, etc.).

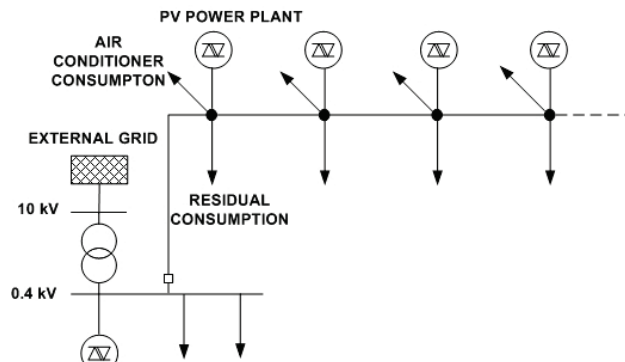

Figure 4 Part of the distribution network modelled in PowerWorld

Consumption of air conditioner and residual consumption are modelled as load curves with 72 time points. Each time point corresponds to one time interval of 10 minutes and measurement data presented in Fig. 2 are used as input data. Also, measured data of PV power plant production presented in Fig. 3 are used as a generation pattern for modelled PV power plants.

3 Simulations and results

3.1 Description of the simulation scenarios

In order to investigate the impact of air conditioner consumption and PV power plant production on

distribution network, four simulation scenarios are simulated and analysed:

Scenario 1 – base case scenario without PV power plants. Air conditioner consumption and residual consumption load curves are modelled according to measured data. This scenario represents the base case and all results from the other scenarios will be compared to the results of Scenario 1.

Scenario 2 – base case scenario expanded with 1 PV power plant connected to every radial feeder (3 PV power plants totally). The PV power plant is located in the middle of the radial feeder.

Scenario 3 – base case expanded with 3 PV power plants connected to every radial feeder (9 PV power plants totally). One PV power plant is connected at the beginning of the radial feeder, one in the middle and one at the end.

Scenario 4 – base case expanded with 5 PV power plants connected to every radial feeder (15 PV power plants totally).

Installed capacity of every modelled PV power plant is 10 kWp.

3.2 Simulation results

For each scenario, 72 successive simulations of power flows for every time point are made. The results are recorded and the active power supplied from the 10 kV distribution network is presented.

3.2.1 Results for the Scenario 1

In the Scenario 1, there are no installed PV power plants. The active power supplied from the 10 kV distribution network (dashed line) is presented in Fig. 5 together with the residual consumption of all family houses (dotted line) and air conditioner consumption of all family houses (full black line).

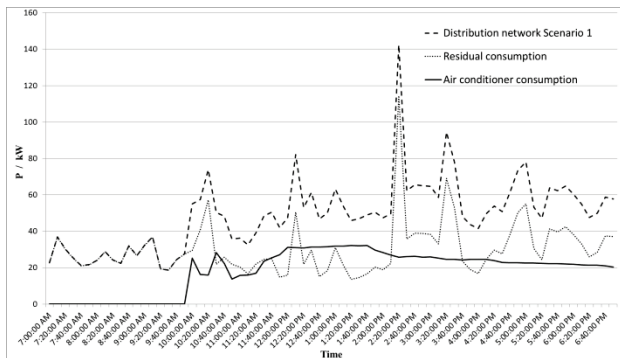

Figure 5 Results for the Scenario 1

3.2.2 Results for the Scenario 2

In the Scenario 2, only one installed PV power plant at every radial feeder is assumed. The active power supplied from the 10 kV distribution network (dotted line) is presented in Fig. 6 together with the active power supplied from the network obtained in Scenario 1 (dashed line). Also, total production of the all 3 PV power plants is presented (grey columns).

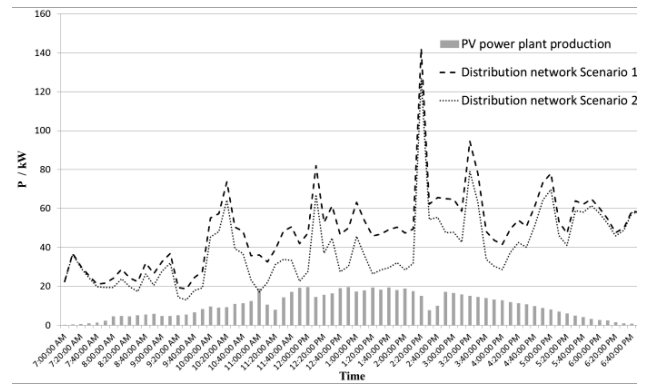

Figure 6 Results for the Scenario 2

3.2.3 Results for the Scenario 3

In the Scenario 3, three installed PV power plants at every radial feeder are assumed. The active power supplied from the 10 kV distribution network (dotted line) is presented in Fig. 7 together with the active power supplied from the network obtained in Scenario 1 (dashed line). Also, total production of the all 9 PV power plants is presented (grey columns).

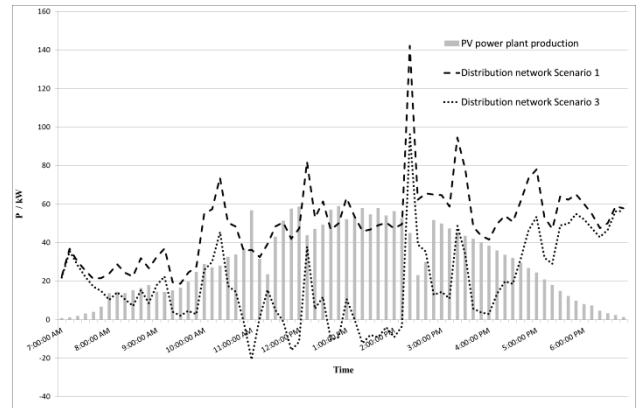

Figure 7 Results for the Scenario 3

3.2.4 Results for the Scenario 4

In the Scenario 4, five installed PV power plants at every radial feeder are assumed. The active power supplied from the 10 kV distribution network (dotted line) is presented in Fig. 8 together with the active power supplied from the network obtained in Scenario 1 (dashed line). Also, total production of the all 15 PV power plants is presented (grey columns).

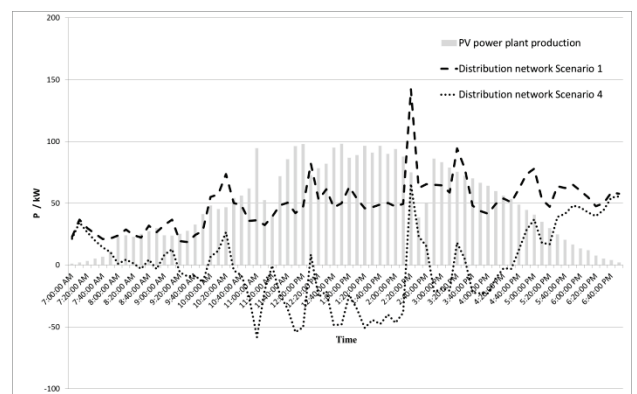

Figure 8 Results for the Scenario 4

3.3 Analysis of the results

As it can be seen from Fig. 5, time diagram of the active power supplied from the distribution network in the Scenario 1 depends on the family houses residual consumption. There are sudden peaks in distribution network active power caused by residual consumption. The consumption of air conditioners increases the level of active power supplied from the network but does not change significantly the shape of the time diagram.

When 3 PV power plants are installed it can be concluded that the level of distribution network active power is slightly reduced (see Fig. 6) as well as the distribution network active power peaks.

As the number of installed PV power plants is growing, active power needed from the distribution network is reduced and in some moments a surplus of energy is present so the energy is transferred to the distribution network (negative values of distribution network active power in Fig. 7 and Fig. 8).

4 Simulation of the demand side load management

The goal of the demand side load management analysed in this paper is to reduce peaks in active power supplied from the distribution grid when PV power plants are connected. It is assumed that demand side load management is conducted using air conditioners installed in family houses. When active power supplied from the distribution network is higher than the specified threshold, demand side load management is activated and air conditioners in specific family houses are turned off.

In order to provide the load management in distribution system, it is necessary to make at least these technical steps: installation of smart meters for all air conditioning units, installation of the central control unit in transformer station and connecting the energy storage unit in distribution grid. The last step is to set up the communication between all air conditioning units, the energy storage device and the central control unit.

4.1 Proposed algorithm for load management

Load management algorithm assumes coordinated control of air conditioning units depending on the electric power demand on transformer station and thus reducing peak demand in a part of distribution system. Distribution system operator (DSO) can set up the limit value of demand power and all other values are obtained by smart measuring.

Fig. 9 presents the proposed algorithm for load management, and the symbols used in Fig. 9 are:

P_{TS} : electric power demand on transformer station;

P_{LIM} : limit value of demand power;

P_{ACx} : rated power of one air conditioning unit.

At the beginning it is necessary to initialize input data (P_{TS} , and P_{ACx}) from the smart meters and DSO have to set up the limit value of demand power (P_{LIM}). The next step is checking whether active power supplied from the distribution network is higher than the specified threshold ($P_{TS} > P_{LIM}$) or not. If it is not, check if $P_{TS} < 0$, and if it is, then charge the energy storage unit.

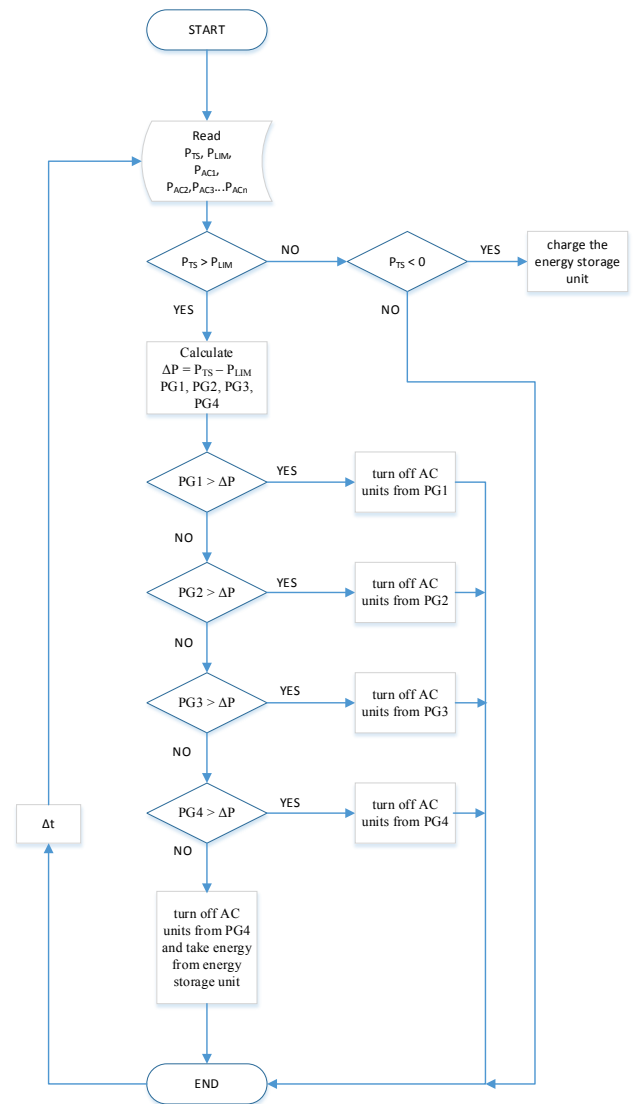

Figure 9 Block diagram of the proposed algorithm for smart load management

If $P_{TS} > P_{LIM}$ then difference (ΔP) between P_{TS} and P_{LIM} as well as active power of air conditioning units groups $PG1$, $PG2$, $PG3$ and $PG4$ are calculated:

$$PG1 = \sum_{x=1}^{n/4} P_{AC4x} \quad (1)$$

$$PG2 = \sum_{x=1}^{n/4} (P_{AC4x} + P_{AC4x-1}) \quad (2)$$

$$PG3 = \sum_{x=1}^{n/4} (P_{AC4x} + P_{AC4x-1} + P_{AC4x-2}) \quad (3)$$

$$PG4 = \sum_{x=1}^{n/4} (P_{AC4x} + P_{AC4x-1} + P_{AC4x-2} + P_{AC4x-3}) \quad (4)$$

Group $PG1$ consists of powers of every fourth air conditioning unit, starting with the fourth one. Group $PG2$ consists of power of group $PG1$ plus every fourth air conditioning unit, starting with the third one (half of all AC units) etc.

The next step is checking of condition $PG1 > \Delta P$:

if $PG1 > \Delta P$, turn off AC units from $PG1$;
 if not, check $PG2 > \Delta P$;
 if $PG2 > \Delta P$, turn off AC units from $PG2$;
 if not, check $PG3 > \Delta P$;
 if $PG3 > \Delta P$, turn off AC units from $PG3$;
 if not, check $PG4 > \Delta P$;
 if $PG4 > \Delta P$, turn off AC units from $PG4$;
 if not, turn off AC units from $PG4$ and take energy from energy storage unit.

4.2 Simulation of proposed demand side load management

Scenarios 2-4 are simulated again with the described load management applied. Threshold for load management activation is set to + 50 kW.

Active powers supplied from the network for the Scenario 2 with (dotted line) and without (dashed line) demand side load management are presented in Fig. 10. LM stands for load management. The straight black line in Fig. 10, presents the threshold. As it can be seen from Fig. 10 all peak values of distribution network active power except two are reduced below the threshold. Only peaks at 2:40 PM and 3:20 PM are above threshold and cannot be eliminated with load management. For these two peaks, energy from the energy storage unit is necessary but energy storage is not simulated in this paper.

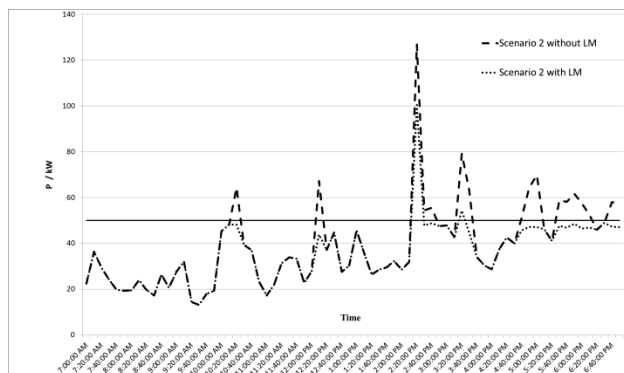

Figure 10 Comparison of results for the Scenario 2 with and without load management

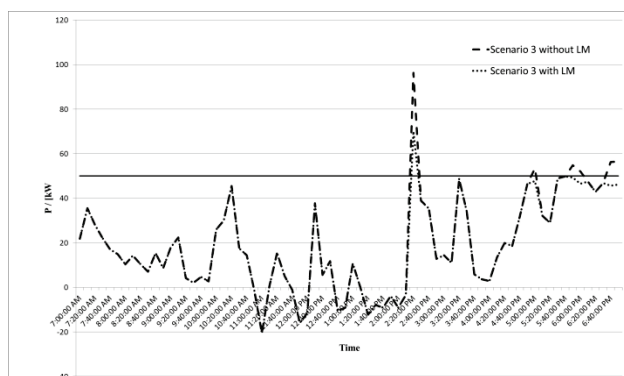

Figure 11 Comparison of results for the Scenario 3 with and without load management

Active powers supplied from the network for the Scenario 3 with (dotted line) and without (dashed line) demand side load management are presented in Fig. 11. Now, all the peak values of network active power except one (at 2:40 PM) are eliminated.

Active powers supplied from the network for the Scenario 4 with (dotted line) and without (dashed line) demand side load management are presented in Fig. 12. In this scenario when 15 PV power plants are installed and when demand side load management is active, all peak values of network active power are eliminated.

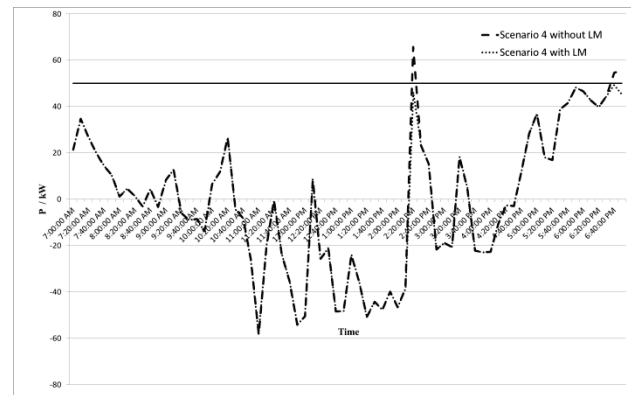

Figure 12 Comparison of results for the Scenario 4 with and without load management

5 Conclusion

In this paper, the influence of demand side load management on the distribution network with PV power plant is being investigated using developed computer model. The paper proposes the algorithm for load management in real distribution network using air conditioning units. The main goal of the proposed load management is in shaving the peak load of distribution system by control of air conditioning system units in different scenarios of PV plant expansion. Based on the measurements carried out, the simulation model of the part of power distribution network of the city of Osijek has been created. Computer model is used to simulate two sets of simulations: the influence of PV plant expansion on distribution network and load management of distribution network with mentioned PV power plants.

Computer simulations show that PV power plant has beneficial effect on distribution network in terms of decreasing demand level. As this kind of power plants strongly rely on weather conditions, simulations also showed increased imbalance in distribution network. By adding load management scheme (by air conditioning units), and also with the included electric power storage, the results of simulation showed that successful elimination of the peak load in distribution system could be done.

Acknowledgements

This research is a result of the project "Load Management in Distribution System with Photovoltaic Power Plant Using Smart Metering" which is supported by University of Osijek, Croatia.

6 References

- [1] Moldernik, A.; Bakker, V.; Bosman, M. G. C.; Hurink, J. L.; and Smit, G. J. M. Domestic Energy Management Methodology for Optimizing Efficiency in Smart Grids. //

- Proceedings of 2009 IEEE Bucharest Power Tech Conference / Bucharest, 2009, pp 1-7.
- [2] United States Department of Energy 2003. The Micro-CHP Technologies Roadmap. // Proceedings of the 21st Century Residential Energy Needs Meeting, 2003, pp. 1-17.
- [3] Kaluder, S.; Šljivac, D.; and Miletić, S. The Optimal Placement of Distributed Generation. // Tehnicki vjesnik-Technical Gazette. 19, 3(2012), pp. 535-541.
- [4] Moldes, E. R. Flexible load management in Smart grids. Master Thesis, Aalborg Universitet, 2013.
- [5] Carvallo, A.; Cooper, J. The Advanced Smart Grid – Edge Power Driving Sustainability, Artech House, Norwood, 2011.
- [6] Ekamayake, J.; Liyanage, K.; Wu, J.; Yokohama, A.; Jenkins, N. Smart Grid – Technology and Applications, John Wiley & Sons, Chichester, 2012.
- [7] U. S. Department of Energy, Smart Grid / Department of Energy, 2012-06-18.
- [8] Hammerstrom, D. J.; Pacific Northwest Gridwise Testbed Demonstration Projects, Part I. Olympic Peninsula Project, 2014-01-15
- [9] Klaić, Z.; Šljivac, D.; Fekete, K.; and Kraus, Z. Load Management Scheme Using Air Conditioning Electric Power Consumption and Photovoltaic Power System Generation. // Journal of Energy and Power Engineering. 8 (2014), pp. 1926-1932
- [10] Tran-Quoc, T.; Sabonnadiere, J. C.; Hadjsaid, N.; Kieny, Ch. Air Conditioner Direct Load Control in Distribution Networks // Proceedings of 2009 IEEE Bucharest Power Tech Conference / Bucharest, 2009, Pp. 1-7.
- [11] Gustafson, M. W.; Baylor, J. S.; Epstein, G. Estimating air conditioning load control effectiveness using an engineering model. // IEEE Transactions on Power Systems. 8, 3(1993).
- [12] Bargiotas, D.; Birdwell, J. D. Residential Air Conditioner Dynamic Model for Direct Load Control. // IEEE Transactions on Power Delivery. 3, 4(1988).
- [13] Liao, G.-W. Application a Novel Evolutionary Computation Algorithm for Load Forecasting of Air Conditioning. // Power and Energy Engineering Conference (APPEEC), Asia-Pacific, 2012.
- [14] Liu, S.; Chen C.; Duan, W. The Research on Technology of Periodic Stopping of Central Air Conditioning Based on Modeling and Simulation of Demand Response. // China International Conference on Electricity Distribution (CICED 2012), Shanghai, 2012.
- [15] Wei, D.-C.; Chen, N. Air Conditioner Direct Load Control by Multi-pass Dynamic Programming. // IEEE Transactions on Power Systems. 10, 1(1995).
- [16] Chu, C.-M.; Jong T.-L.; Huang Y.-W. Mitigating DLC Constraints of Air-conditioning Loads Using a group-DLC Method. // Power Engineering Society General Meeting, IEEE, 2007.
- [17] Lee, T.-F.; Cho, M.-Y.; Hsiao, Y.-C.; Chao, P.-J.; Fang, F.-M. Optimization and Implementation of a Load Control Scheduler Using Relaxed Dynamic Programming for Large Air Conditioner Loads. // IEEE Transactions on Power Systems. 23, 2(2008).
- [18] Chu, C.-M.; Jong, T.-L. A Novel Direct Air-Conditioning Load Control Method. // IEEE Transactions on Power Systems. 23, 3(2008).
- [19] City of Columbia, Missouri Load Management. URL: <https://www.gocolumbiainfo.com/WaterandLight/Home/load.php>. (25.11.2014)
- [20] Power World Simulator, <http://www.powerworld.com/>
- [21] Stojkov, M.; Trupinić, K.; Nikolovski, S. Procedure for Determination of Harmonic Distortion along the Distribution Network. // Tehnicki vjesnik-Technical Gazette. 16, 4(2009), pp. 1-26

Authors' addresses

Zvonimir Klaić, Ph.D, Assistant Prof.

J. J. Strossmayer University of Osijek
Faculty of Electrical Engineering Osijek
Kneza Trpimira 2b, 31000 Osijek, Croatia
E-mail: zvonimir.klaic@etfos.hr

Krešimir Fekete, Ph.D.

J. J. Strossmayer University of Osijek
Faculty of Electrical Engineering Osijek
Kneza Trpimira 2b, 31000 Osijek, Croatia
E-mail: kfekete@etfos.hr

Damir Šljivac, Ph.D, Full Prof.

J. J. Strossmayer University of Osijek
Faculty of Electrical Engineering Osijek
Kneza Trpimira 2b, 31000 Osijek, Croatia
E-mail: damir.sljivac@etfos.hr